

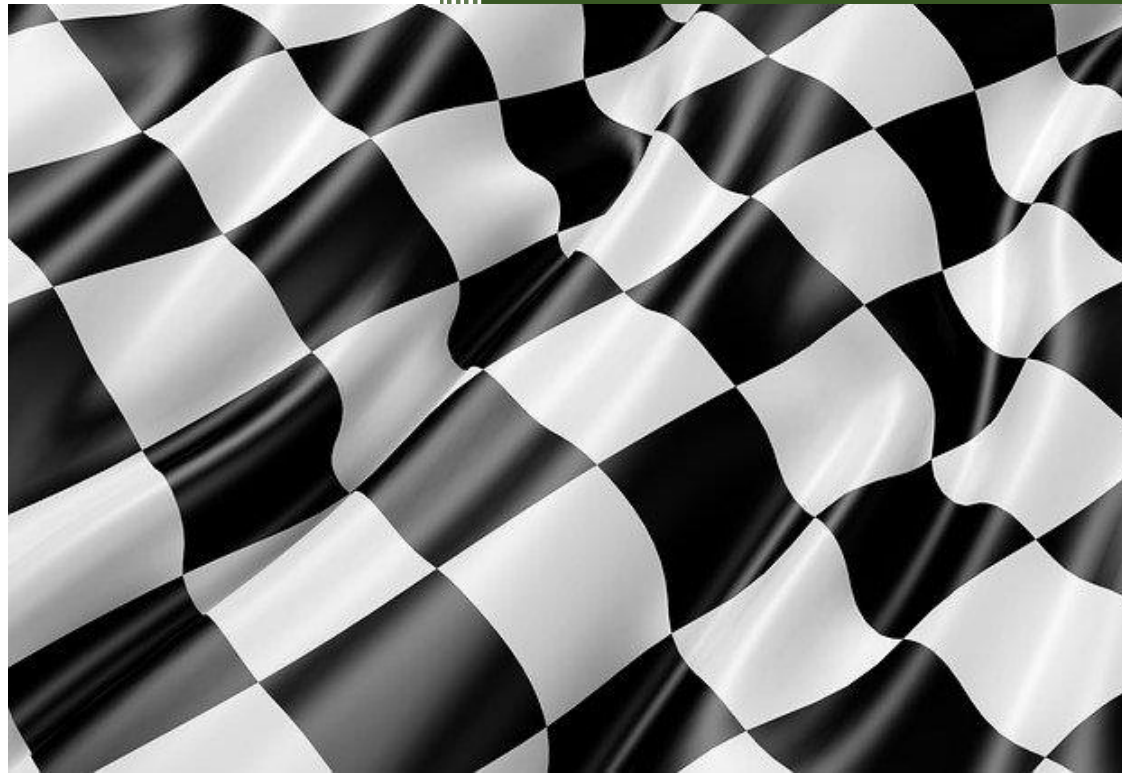

2022

MSA National Karting Standing Supplementary Regulations



Version 4

9 May 2022

Ref: 162557

REVIEW AND AMENDMENTS

Amendments and updates to the rules will be recorded in the Amendment Record, detailing the amendments, date applicable and a short summary of amendments.

AMENDMENT RECORD

<i>Modified SSR / ART</i>	<i>Date applicable</i>	<i>Date of Publication</i>	<i>Clarifications</i>
Art 39 c	09.05.2022	09.05.2022	Regulation amendment
Art 7a	10.03.2022	10.03.2022	Regulation amendment
Art 9 b	10.03.2022	10.03.2022	Regulation amendment
Art 39 e	10.03.2022	10.03.2022	Prizes amended
Art 5 a, f, g	14.02.2022	14.02.2022	Wording added, deleted, and changed
Art 7 a	14.02.2022	14.02.2022	Wording deleted
Art 8 f	14.02.2022	14.02.2022	Wording deleted
Art 9 a, c, d	14.02.2022	14.02.2022	Wording deleted, added and penalty changes
Art 24 f	14.02.2022	14.02.2022	Wording deleted
Art 29	14.02.2022	14.02.2022	Wording amended
Art 34 a, d	14.02.2022	14.02.2022	Wording and regulation amendment
Art 52 a	14.02.2022	14.02.2022	Regulation amendment

Contents

SECTION A	4
1. ADMINISTRATION	4
2. CLASSIFICATION OF COMPETITIONS.....	5
3. ORGANISING PERMITS.....	5
4. CIRCUITS	5
SECTION B.....	6
5 THE FOLLOWING EQUIPMENT IS MANDATORY FOR ALL EVENTS:.....	6
6. MSA PERMIT ISSUE	7
7. OFFICIALS.....	7

SECTION C	8
8. RIGHTS AND DUTIES OF ORGANISERS	8
SECTION D	9
9. PENALTIES	9
SECTION E	19
10. COMPETITORS – ENTRANT REQUIREMENTS	19
11 LICENCES	19
SECTION F	22
12 SAFETY CLOTHING	22
13 DRIVERS BRIEFING	22
14 SAFETY PROCEDURES	22
SECTION G	23
15 CONDUCT	23
16 DESIGNATED REVVING AREA	24
SECTION H	24
17 WITHDRAWAL FROM AN EVENT OR RACE	24
18 FIRE EXTINGUISHERS	24
19 FLAGS	24
20 TIMEKEEPING AND TRANSPONDERS	24
21 VEHICLES - GENERAL	25
22 RACING NUMBERS	25
SECTION I	26
23. PRACTICING	26
24 RACING – GENERAL REGULATIONS AND FORMAT APPLICABLE TO ALL COMPETITIONS	26
25 ROLLING STARTS	27
26 STANDING STARTS	28
27 SIGNAL TO START A RACE	29
28 SIGNAL TO FINISH THE RACE	29
29 CLASSIFICATION OF A FINISHER	29
30 REFUELING	29
31 STOPPING THE RACE	30
32 TELEMETRY/DATA LOGGING/RADIO COMMUNICATION	30
33 ON BOARD CAMERAS	30
34 WEIGHING SCALE	30
35 RECOVERY	31
36 OUTSIDE ASSISTANCE	31
SECTION J	31

37	VARIATION OF REGULATIONS	31
38	POINTS SCORING	31
SECTION K.....		32
39	SA NATIONAL CHAMPIONSHIPS	32
40	EVENT FORMAT	33
41	OBSERVATION FORM	33
42	PROTESTS.....	34
43	APPEALS.....	34
SECTION L.....		34
44	KARTING SPECIFICATIONS – GENERAL.....	34
45	CHASSIS	34
SECTION M		34
46	HOMOLOGATION	34
47	CHASSIS TYRES AND ENGINES	35
48	HOMOLOGATION OF LOCALLY MANUFACTURED CHASSIS	35
49	HOMOLOGATION PROCEDURE	35
50	GENERAL.....	38
51	HOMOLOGATED CHASSIS BRANDS.....	38
52	HOMOLOGATED ENGINES.....	38
SECTION N		39
53	PROCEDURES TO INTRODUCE A NEW CLASS.....	39
54	ACCREDITED IMPORTERS.....	39

SECTION A

1. ADMINISTRATION

- a) Karting is administered under the provisions of the General Competition Rules of Motorsport SA (GCR's), these Standing Supplementary Regulations (SSR's), the class specific Regulations and other regulations and instructions which may from time to time be issued by Motorsport SA (hereinafter referred to as MSA) and the Supplementary Regulations published for each particular kart competition.
- b) Where there is a contradiction between the GCR's and these SSR's the latter shall take precedence. Where there is a contradiction between these SSR's and the pertinent national class regulations, the latter shall take precedence.
- c) NB: The SSR's applicable to circuit racing do not apply to karting, except in cases where kart racing is held in conjunction with car and/or motorcycle racing. In terms of GCR 84 (i), individual event supplementary regulations (SR's) may not conflict with these SSR's.

- d) These Standing Supplementary Regulations may generally only be amended for safety reasons or because of force majeure.
- e) It must be noted that MSA Regional and Club Karting regulations may not be in conflict with these MSA National Karting Regulations, unless approval to the contrary has been provided by the Karting Management Group in writing. Where individual Regional and Club Karting regulations are silent on an issue, and in the event of any dispute, these National SSR's will take precedence.

2. CLASSIFICATION OF COMPETITIONS

Refer to GCR's 39 - 43, 50 and 56 - 61.

3. ORGANISING PERMITS

An application for a permit for a kart competition must be made in accordance with GCR 78.

4. CIRCUITS

- a) Two types of circuit will be approved, i.e. permanent and temporary. A permanent circuit is one the main features of which can only be changed by physical reconstruction. A temporary circuit is one defined by markings that can be readily moved.
- b) Plans for new circuit projects or modifications to existing circuits must be sent to the MSA Sporting Services Manager for approval prior to any works being undertaken. Failure to do so may result in the circuit/modifications not being approved by MSA.
- c) All new permanent circuits intending to stage MSA sanctioned events are to conform fully to the CIK circuit regulations for at least a "C" grade circuit (in the case of national events), or the appropriate standard set out by the MSA national circuit safety committee in conjunction with MSA.
- d) A 1:500, or larger scale, dimensioned plan of every circuit shall be submitted to MSA. In the case of temporary circuits, a plan must accompany each application for a permit. In the case of permanent circuits, a dimensioned plan, drawn roughly to a scale of 1:500, or larger must be filed with MSA on application and, after inspection and approval of the circuit, a circuit licence will be issued at an annual fee. At least 8 weeks' advance notice must be given when applying for a permanent circuit licence. (7 weeks prior to the first scheduled national championship event, for existing circuits applying for an annual license renewal)
- e) The plans of all new circuits are to be approved by MSA prior to construction.

Where the CIK circuit specifications are not used the following obligatory circuit installations will apply:

- f) Pits - The pits shall be fenced and protected as are other enclosures and shall have a firm surface. The entry to the pits from the circuit shall be immediately preceded by a chicane or bend to reduce the speed of a kart substantially. The width of the lane after the chicane shall be less than the width of two karts. There shall be an entrance to the circuit from the pits, controlled by officials.
- g) Pre-race paddock - There shall be an area in which karts can be assembled prior to a race. The pre-race paddock must be able to accommodate at least 34 karts. A line is to be painted across the pit road at a reasonable distance after the exit from the pre-race paddock but before entry onto circuit, to indicate the end of the pit lane.
- h) Weighing area - A covered, controlled area must be provided adjacent to the pit entrance for the weighing of karts. The entry lane leading to the weighing area, and the weighing area itself, must be controlled and access must be restricted to officials and relevant competitors only.

- i) Parc Ferme - The Parc Ferme shall be immediately adjacent to the weighing area or connected to it in a manner capable of being controlled. Access to this area is restricted to accredited competitors and officials only.
- j) Access - Access to all enclosures, and to the circuit, shall only be by means of controlled entrances.
- k) 25-metre line - A yellow line of 100mm to 150mm width must be painted across the width of the circuit 25 meters before the start line.
- l) 90-metre line - A RED line of 100mm to 150mm wide must be painted across the width of the circuit not less than 90 meters before the start line.
- m) Starting Grid - Two pairs of continuous white lines, marking lanes 2m wide with an ideal minimum of 2m separating the two lanes must be painted for a maximum distance of 90m prior to the start line and with due consideration to the limitations of the circuit. (See FIA CIK Karting Circuits Appendix 10 for more details)
- n) The maximum number of starters will be determined as follows, unless otherwise stated on the circuit licence:
 - i) Circuits up to 900m in length

Classes less than 99cc engine capacity	-	30
Classes greater than 100cc engine capacity	-	24
 - ii) Circuits over 900m in length

All Classes	-	34
-------------	---	----
- o) The timekeeping, lap scoring, public address and secretarial areas must afford protection from the elements and be suitable for the intended purpose.

SECTION B

5 THE FOLLOWING EQUIPMENT IS MANDATORY FOR ALL EVENTS:

- a) Signalling equipment as follows:

1) For the Clerk of the Course (or his designated flag issuing official):

Red flag, white flag, black flag with orange circle, black flag. Flag divided diagonally into black and white halves and a blue flag with red diagonal cross. A set of white, non-reflective numbers with a recommended size of not less than 300mm high by 170mm wide with a 30mm stroke, which can be suitably mounted to be visible to competitors on the circuit. As an alternative, the numbers may be written clearly on a blackboard with white chalk or alternatively a white board and non-permanent marker.

A public address system available to the Clerk of the Course and/or the Chief Paddock Marshal for communication with competitors (a hand-held megaphone is acceptable as a minimum).

- b) For each Flag Marshal:

Flags as per Appendix "H" of the MSA Handbook, and where applicable Sec G 18 of these regulations.

- c) For the Starter:

MSA flag, black and white chequered flag, green flag with yellow chevron (to signify a false start, **positioned with the Marshals at turn 1, who will display under instruction of the Chief Marshal**) blue flag, and blue flag with red diagonal crosses (to signify to a competitor that he or she has been/is about to be lapped) and a lap display board for showing the competitors the number of laps remaining in the race. A starter's sheet, under the control of the Secretary of the Meeting.

d) For the Chief Paddock Marshal:

A shrill whistle or hooter. If their use has been approved by MSA, lights may be substituted for the starting flag. One blackboard and chalk or suitable means of writing and displaying notices. A minimum of eight fire extinguishers with a combined capacity of at least 60kg, four of which must be in the paddock in an immediately visible position, the remaining four being strategically placed around the circuit. All extinguishers must bear satisfactory evidence that they are in working order and/or that they have been serviced within the previous 12 months. (Note: This clause shall apply to permanent kart circuits only. For street races and long-circuit races, the firefighting equipment is to be increased proportionately.) Circuit cleaning equipment consisting of Shovels, Brooms, Suitable cleaning agent for removing oil (cement may be used provided it is brushed off the circuit after use).

e) First aid equipment:

Refer Appendix L in the MSA Handbook.

f) Official Notice Board:

An official notice board must be prominently sited. The board must be lockable to prevent notices and results from being unofficially removed. The use of a VNB (Virtual Notice Board) will be used.

g) Scale of the Day:

A scale, suitable for the weighing of karts and with a current certificate of accuracy, as well as certified control weights totalling not less than 100kg, which will serve to adjust the scale. For national championship events the certificates of accuracy must be dated within 7 14 days prior to the commencement of the event. Note: Any discrepancies on measurements based on the 100kg test weights will be used to adjust the weight of karts taking part in the event accordingly.

6. **MSA PERMIT ISSUE**

It is a requirement that any competition for karts as described in these regulations shall be held under a permit issued by MSA.

7. **OFFICIALS**

a) **SENIOR EVENT OFFICIALS: (CoC & Stewards)**

A Clerk of the Course applying for an upgrade to an 'A' grade licence must be approved by the MSA Karting Management Group.

GCR 151 requires that the MSA Steward for National Championship events must hold at the very least a grade "C" Clerk of the Course licence valid for karting.

b) **CHIEF COURSE MARSHAL:**

In conjunction with GCR 170 and 171 shall be responsible for:

Ensure that the correct number of marshals are deployed as per the minimum as required according to

MSA circuit safety inspection, that the track surface and marking and protective works are maintained in good order throughout the meeting. Ensuring that the firefighting equipment is readily available and correctly sited and that his assistants and the paddock marshals are familiar with its operation. Ensuring that the track-cleaning units are sited at suitable points.

Supervising the removal from the track of any kart that may have stopped on the track. Karts may not be placed on the top of the tyre barriers. Supervising that all entrances to the track proper are manned and that no unauthorized person comes within this area. Normally more than four assistants will be required and, if enclosures are not surrounded by fencing, there must be Course Marshals stationed at strategic points between all enclosures and the track proper.

c) CHIEF PADDOCK MARSHAL:

To maintain orderly conduct in the paddock and/or pit area. To notify competitors to assemble on the dummy grid prior to each heat or race. To ensure that no competing vehicle goes onto the circuit unless it has been approved by the Scrutineer(s). To exclude any unauthorized person from the paddock and/or pit area.

d) TEAM MANAGERS (for international events)

Team managers may be proposed by a championship promoter to be nominated by MSA Karting Management Group and will be solely responsible for the conduct of all members of the team, both on and off the circuit. This includes all assistants to the team drivers. All instructions given by the team manager to team members and assistants shall be firm and binding and his decision on a matter of policy, action, or behaviour, shall be final. On completion of any international competition whether taking place in South Africa or in any other country, the team manager shall submit, in writing a full report on the performance and conduct of each team driver to the MSA Karting Management Group and to the CEO, of MSA. This report shall be submitted within 21 days of the last day of the competition.

SECTION C

8. RIGHTS AND DUTIES OF ORGANISERS

Refer to Part VI of the GCR's. In addition, the following rules will apply:

- a) Amalgamation of classes may take place in all events if there are less than 10 entries, subject to the proviso that:
- KZ or similar 6-speed karts may never be amalgamated with any other non-gearbox class.
 - Bambino and Kid ROK classes may never be combined with each other or other classes under any circumstance.
 - The Micro & Mini classes may be combined, provided they are scored separately within their own classes.
 - Junior Max, Senior Max and OKJ may be combined, provided they are scored separately within their own classes.
 - Note: The amalgamation does not upgrade any competitor to a higher class and does not serve to help meet the minimum number of starters for any specific class for the purpose of eligibility for championship points. When amalgamating classes, priority will be given to the MSA National classes irrespective of numbers in the class

- b) Padding a class under the guise of amalgamation is not permitted.
- c) A class will be deemed to have achieved the required minimum number of starters, and all races run on the day will score towards the relevant championship, if the class achieved the required minimum number of eligible starters in at least one of the races on the day.
- d) The organizers shall arrange that, in the event of drivers' start positions being determined by qualifying, such shall be carried out in accordance with Section I, Art 24
- e) With regard to the changing of drivers/equipment, the organizers may: Permit a change of driver(s) or make of kart or make of engine where permitted by regulations, from that nominated in the program, provided only a change of driver(s) or kart/engine is involved, and not both, and provided the request is made more than 30 minutes before qualifying practice or the first race in the event of there being no qualifying practice, and provided any such permission does not prevent the participation of a reserve entry. A kart shall not be driven by more than one nominated driver during an event or series of heats or races forming one competition except in an Endurance where more than one driver is permitted as per supplementary regulations.
- f) In the event of a competitor's chassis being damaged beyond immediate repair as the result of an incident during practice, qualifying practice or any race, permit a change of chassis of any make for the following qualifying practice and/or races, provided the Clerk of the Course, in conjunction with the scrutineers, is satisfied as to the non-reparability of the chassis and the circumstances in which it was damaged. Such damaged chassis is to remain in the scrutineering area for the duration of the event. NOTE: Competitors in all classes shall be limited to the use of no more than two engines during any event. These engines are to be nominated and identified at scrutineering.

The same two (2) engines may not be nominated or used by different competitors, i.e. the inter-use of engines between competitors is not permitted.
- g) The organizers may specify fuel and/or provide fuel/oil and impose control measures as provided for in these regulations.
- h) Where a class already has National Status, a regional committee MAY grant it regional status without the need for Club status first.
- i) Where footage is used by officials in the adjudication of any incident, a copy of the footage concerned must be kept for future use.

SECTION D

9. PENALTIES

a) PENALTY FOR TECHNICAL INFRINGEMENTS

Notwithstanding anything stated to the contrary in MSA's General Competition Rules,(Specifically GCR 176) any contravention of the karting technical regulations or specifications will result in automatic exclusion from the relevant race (in circumstances where it can reasonably be assumed that the contravention applied to the specific race only) or from the entire event/race meeting (in all other cases).

Any component and or kart found not to comply with the technical regulations and specifications must be impounded by the relevant officials. The component may be returned to the competitor if the infringement is capable of being rectified (e.g. axle of kart too wide) but only after an admission of guilt form has been filled in, signed by the competitor and submitted to, and accepted by, the Clerk of the

Course.

It is at the discretion of the Clerk of Course to decide whether to return a non-compliant part, in consultation with the TC.

A competitor removing a part/kart from parc fermé that is deemed to be the subject of a technical infringement, as pronounced by the TC, without having signed an admission of guilt form, will automatically be excluded from the race concerned (if it is clear that the infringement was only in respect of the particular race) or from the entire race meeting (in all other instances). Any such exclusion shall be final, without the prospect of protest or appeal.

In the event of a dispute concerning any item/component/part not covered in the relevant regulations or specification sheets, the Technical Consultant shall be empowered to make a ruling as to whether or not a contravention exists and, if found that one does, to recommend an appropriate penalty other than exclusion for imposition by the Clerk of the Course.

b) **PENALTY FOR WEIGHT INFRINGEMENTS**

Competitors and/ or karts found to be underweight will be excluded. The lap times set in the heat will also be disregarded for grid positioning for the next race. Underweight penalties may be used as dropped points.

c) **NOSE CONE**

The black flag with the orange disc will NOT be shown to a driver if his nose cone is no longer in the correct position. If an official reports that the nose cone on one or more karts is/was no longer in the correct position when the kart enters the exit lane to the scale/weighing area, in all situations a 5 second time penalty will be imposed automatically on the driver(s) concerned. This penalty cannot be protested.

Should a driver be found to have tampered with/replaced/realigned or attempted to tamper with/replace/realign the nose cone which was not correctly positioned when entering the exit lane or after the chequered flag was waved, the correct penalty will apply as per the penalty schedule below. For all National events, competitors may not use repaired (e.g. plastic welding, cable ties) nose cones.

DESSIN TECHNIQUE N° 2d

Installation correcte du «Carénage Avant»

Position correcte / Correct position

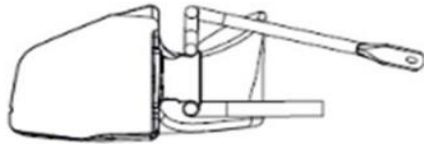

TECHNICAL DRAWING No. 2d

Correct installation of the "Front Fairing"

Position acceptable / Acceptable position

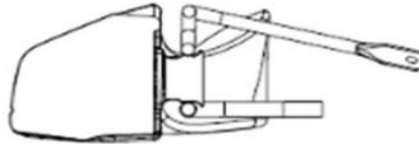

Position non acceptable si une quelconque partie des tubes du para-chocs avant se trouve dans les zones marquées (A).

Not acceptable position if any part of the tubes of the front bumper are in the marked areas (A).

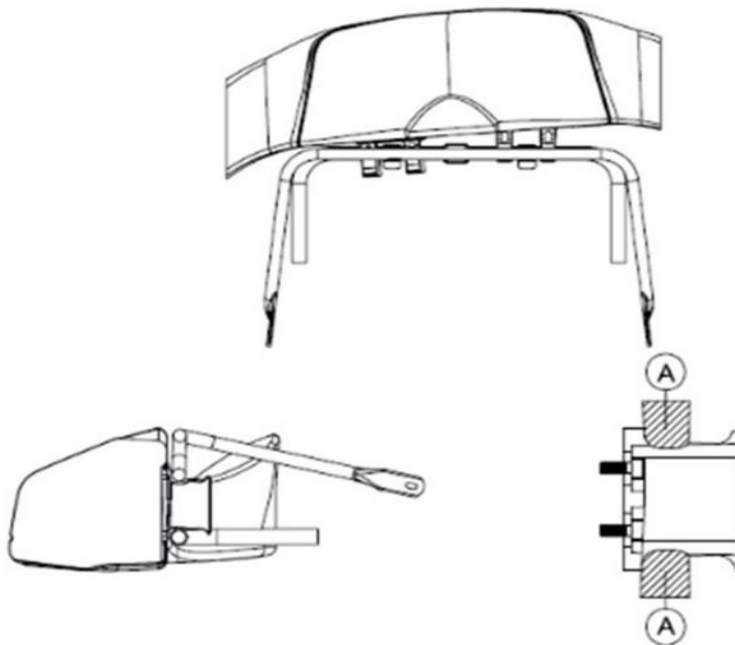

Photographic evidence submitted **ONLY** by the Nose Cone official and or any MSA official listed in the event SR's, of the nose cone dislodgement will be sent to the MSA Steward Clerk of Course and will be deemed as irrefutable evidence in the issuing of a penalty.

Such penalty will automatically be imposed without the requirement for a hearing as envisaged in GCR 175. The Clerk of the Course may empower a deputy / assistant Clerk of the Course to issue nose cone penalties without same having to receive instruction from the Clerk of the Course for each infringement.

Notices pertaining to any such infringements will not be published on a noticeboard but must be disseminated via a VNB (Virtual Notice Board)

Should a competitor's nose cone no longer be in the correct position at the end of Qualifying and/or a race, the penalty applied will be as per the penalty schedule. Notwithstanding the provisions of GCR 175, this decision is non-protetable.

d) **PENALTY CATALOGUE**

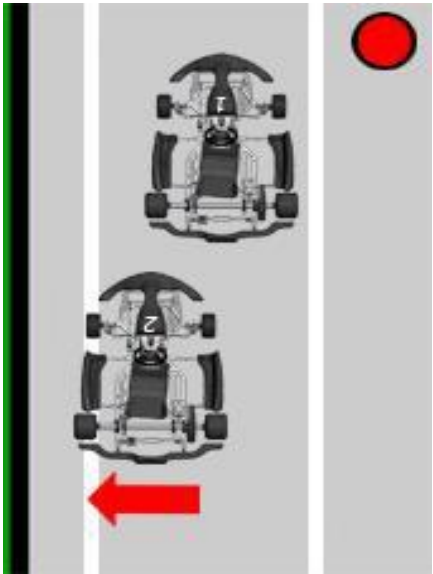
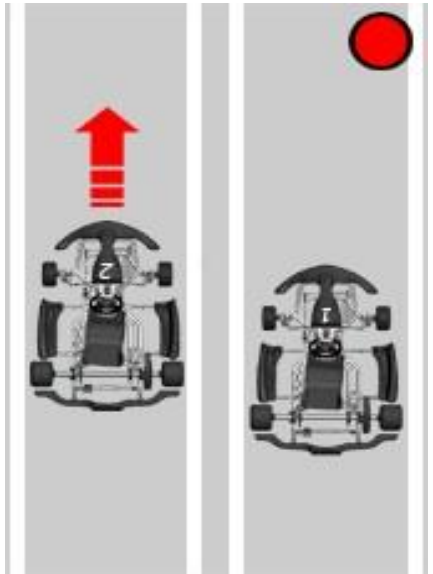
<p>FALSE START (Type A) means Kart 2 leaves the marked corridor during launch phase with at least two tyres before the start has been released. Leaving = the tyres are completely on or outside the corridorline.</p> <p>PENALTY 3 seconds</p>	
<p>FALSE START (Type B) means Kart 2 leaves the marked corridor during launch phase with at least four tyres before the start has been released. Leaving = the tyres are completely on or outside the corridorline.</p> <p>PENALTY 10 seconds</p>	
<p>JUMP-START means that Kart 2 accelerates during launch phase leaving Kart 1 behind before start has been released. It is irrelevant if the start will be repeated afterwards.</p> <p>PENALTY 5 seconds</p>	

CUT-IN means that Kart 1 constricts the drivable section towards the curve center forcing Kart 2 to leave the drivable section either partial or completely for passing the curve. It is irrelevant if the Karts have touched each other or not. A prerequisite is, however, that Kart 2 must be at least 1/3 (front tyres next to side pod) next to Kart 1.

An advantage is at hand, if (either/or):

- Kart 2 suffers a position loss or drop-out.
- Kart 2 suffers a damage leading to a position loss or retirement within the same lap.

PENALTY

2 positions (No Advantage Gained)

5 positions (Advantage Gained)

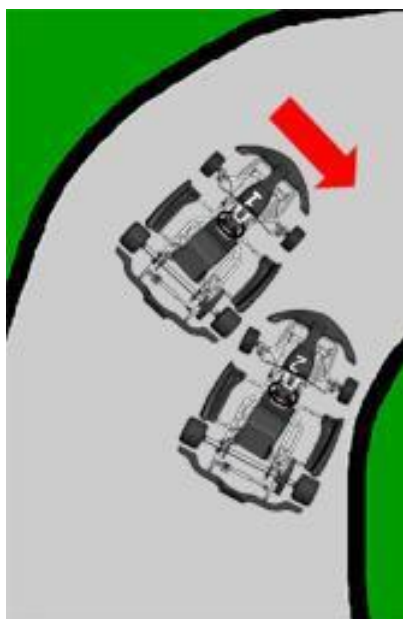

EDGE-INTO means that Kart 2 drives next to Kart 1 (e.g. in order to start an overtaking action) without possessing enough drivable section (including kerbs). It is irrelevant if Kart 2 is completely or partially next to Kart 1 or if Kart 2 is completely or partially off the track.

An advantage is at hand, if (either/or):

- Kart 2 wins a position.
- Kart 1 suffers a position loss or drop-out
- Kart 1 suffers a damage leading to a position loss or retirement within the same lap.

PENALTY

2 positions (No Advantage Gained)

5 positions (Advantage Gained)

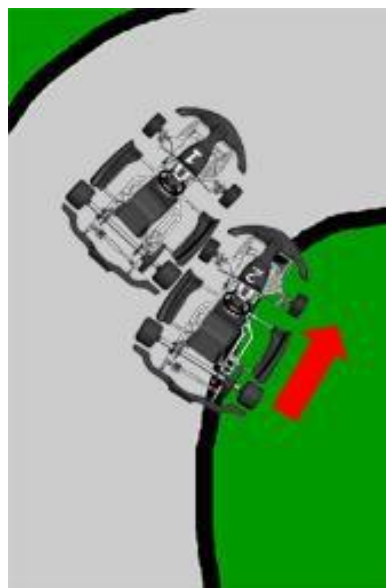

PUSH-OUT means if Kart 1 constricts the drivable section towards the outside line forcing Kart 2 to leave the drivable section either partial or completely.

It is irrelevant if the Karts have touched each other or not.

A prerequisite is, however, that Kart 2 must be at least 1/3 (front tyres next to side pod) next to Kart 1.

An advantage is at hand, if (either/or):

- Kart 1 wins a position.
- Kart 2 suffers a position loss or retirement
- Kart 2 suffers a damage leading in a position loss or retirement on the same lap.

PENALTY

2 positions (No Advantage Gained)

5 positions (Advantage Gained)

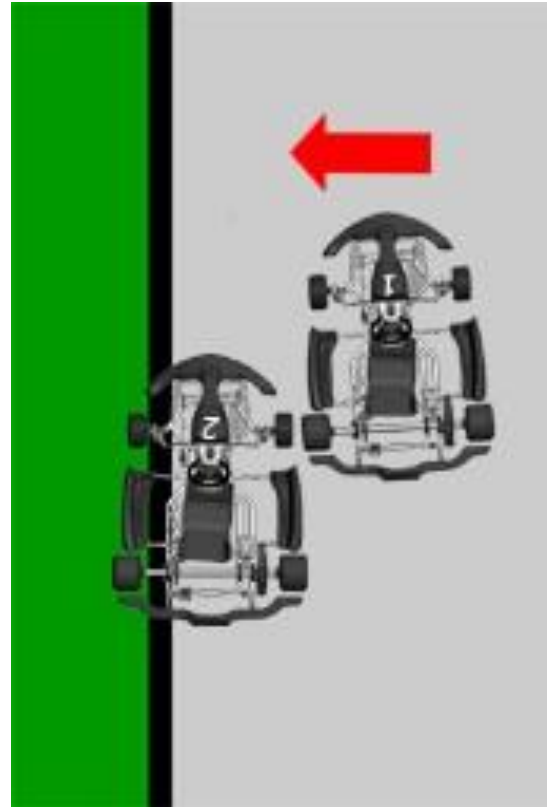

BUMP means that the front of Kart 2 touches the rear of Kart 1.

Neither the reason nor the intensity of the contact is relevant. Only the consequences of the impact are relevant to judge an advantage, not the impact itself.

An advantage is at hand, if (either/or):

- Kart 2 wins a position, and the previous order cannot be restored within the same lap.
- Kart 1 suffers a position loss or retirement
- Kart 1 suffers a damage leading in a position loss or retirement within the same lap.

PENALTY

**Warning (No Advantage Gained)
Black / White flag for Unsportsmanlike behavior**

5 positions (Advantage Gained)

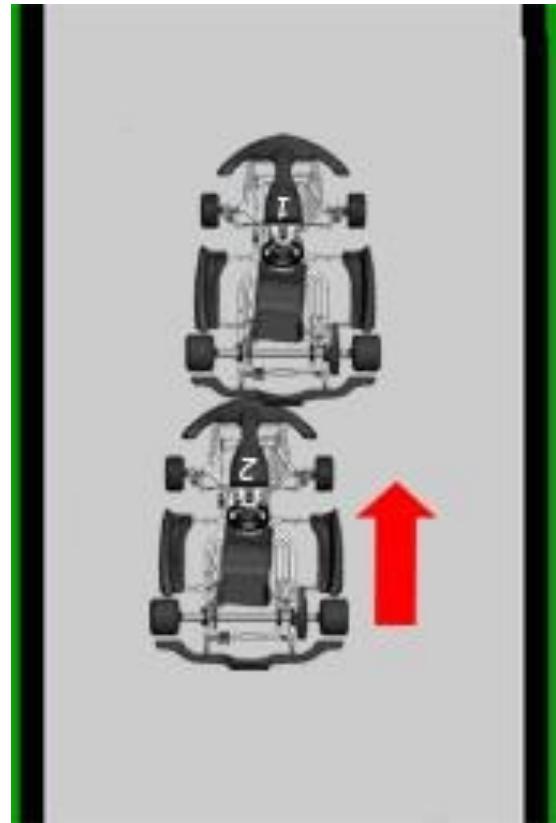

SHORT-CUT means that Kart 2 leaves the track completely and returns to the track at a different section.

It is irrelevant why Kart 2 has left the track.

An advantage is at hand, if (either/or):

- Kart 2 wins a position or gains time which cannot be given back within the same lap.
- Kart 1 or any other is handicapped by the return of Kart 2.
- Kart 1 or any other suffers a position loss or retirement on the same lap by the return of Kart 2.

PENALTY

Warning (No Advantage Gained) Black / White flag for Unsportsmanlike behavior

5 positions (Advantage Gained)



ZIG-ZAG means that Kart 1 changes the driving line more than two times on a straight track section for more than a kart width.

It is irrelevant how far Kart 1 is ahead of Kart 2 or if Kart 2 would have been able to overtake.

An advantage is at hand, if (either/or):

- Kart 1 acts more than once a time this way within the same race.

PENALTY

Warning (No Advantage Gained) Black / White flag for Unsportsmanlike behavior

5 positions (Advantage Gained)

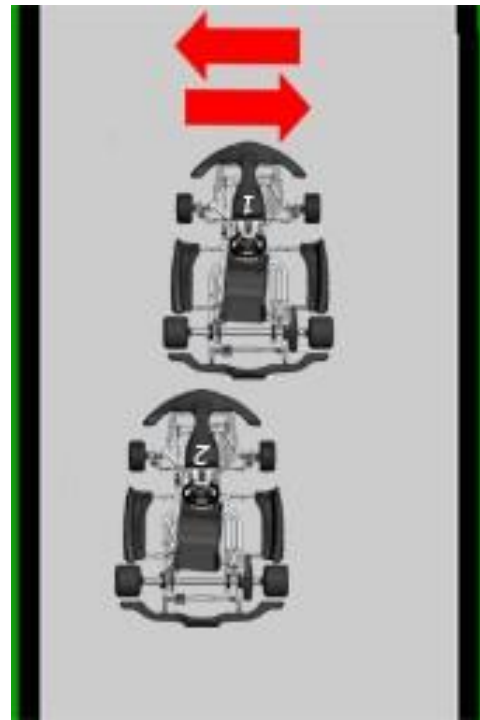

TECHNICAL NON-COMPLIANCE is at hand, if the Kart is not fulfilling the technical regulations in all parts. It is irrelevant, if the technical lack arises before, during or after the race. It is also irrelevant, if the technical lack would have led to an advantage or not. The only relevant thing is the technical condition at the time of examination.

Typical examples for a technical non-compliance are:

- Under-weight
 - Wrong setup (contrary to Class Technical regulations)
 - Wrong fuel, oil, ...
 - Modified parts
- etc.

PENALTY

Exclusion

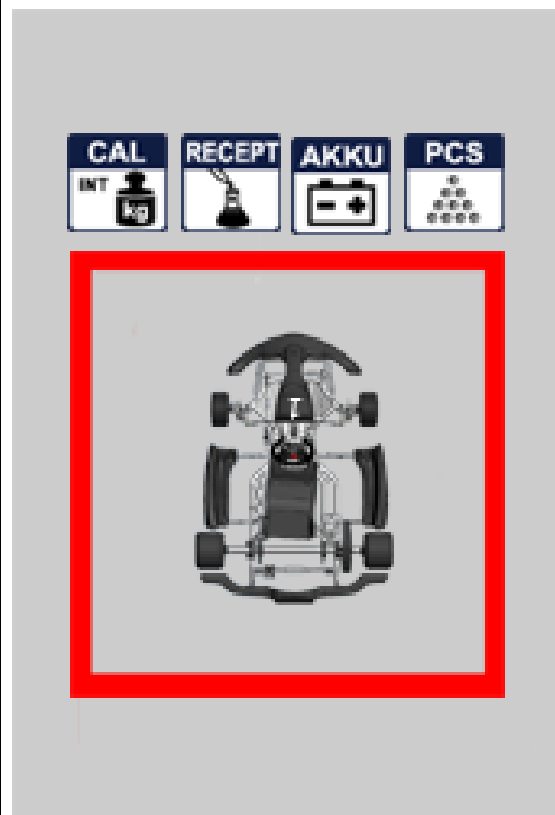

FORMATION FAULT is at hand, if Kart 2 improves its starting position unforced during the formation lap after having crossed the “red line”
(and before the start has been released).

PENALTY

5 second penalty

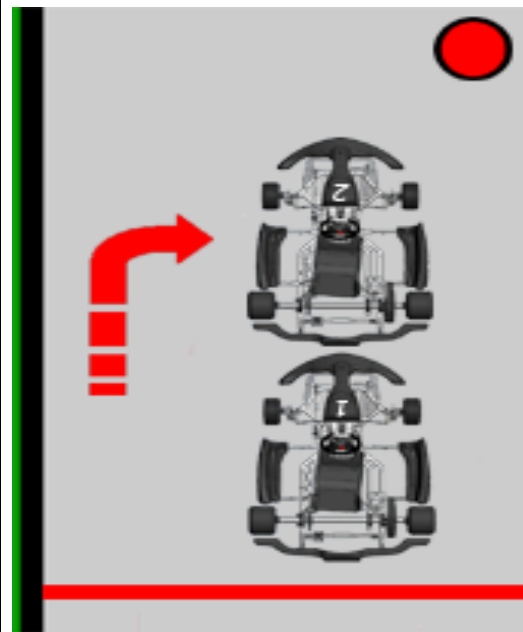

FLAG DISREGARD is at hand, if the driver does not carry out the flag instructions given by either the track personnel or clerk of the course.

It is irrelevant which flag is in question, why the flag has been disregarded or if the violation would have led to an advantage or not.

Typical examples of a flag disregard are:

- Overtaking under yellow flag (see diagram).
 - Continuing the race after receipt of black/orange flag.
- etc.

PENALTY

Race Exclusion

NOTE: This applies to all flags

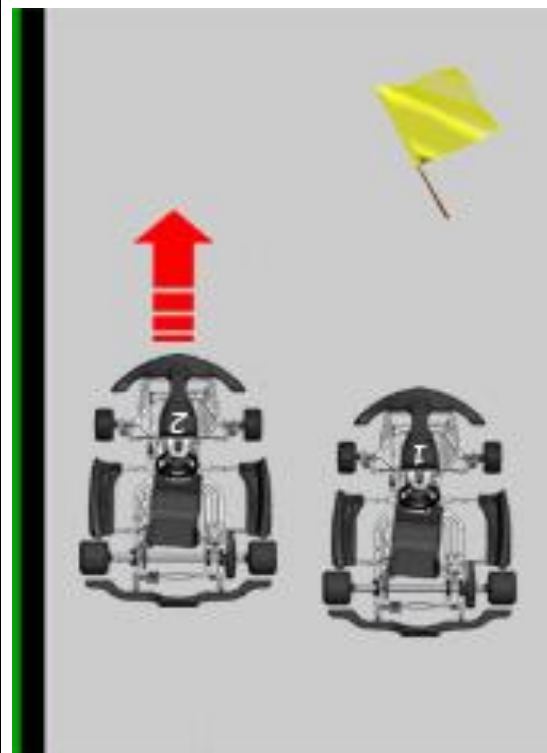

e) **ADDITIONAL PENALTY SCHEDULE**

Additional penalty scale available to officials

DESCRIPTION		PENALTY
i)	Driving in a manner incompatible with general safety	10 seconds, Race or race meeting exclusion
ii)	Contravention of flag signal - Ignore Technical Flag Twice	Black Flag
iii)	Abusive Language, Behaviour or Assault	Race or race meeting exclusion
iv)	Failure to attend Drivers' Briefing	Fine of R 1 500
v)	Failure to obey an Official of the Meeting	Race or race meeting exclusion
vi)	Technical Non-Compliance Report, vehicle, or component ineligible	Race or race meeting exclusion
vii)	Underweight	Race exclusion
viii)	Failure to report to Scrutineering	Race Meeting exclusion
ix)	Incorrectly positioned Nose Cone - Qualifying practice	Deletion of fastest time
x)	Incorrectly positioned Nose Cone - race	5 Seconds penalty
xi)	Tampering with or reattaching, or attempting to tamper with or reattach the Nose Cone during or after a timed qualifying session or race	Race exclusion from class competed in with a report to MSA for possible further action.

- f) **POST RACE SCRUTINY** - After either a race or an event, the Clerk of the Course may instruct that karts shall be placed in possession of the promoters/organisers for examination by the Scrutineers / Technical Consultants to determine if they comply with the regulations.

Any kart failing to comply shall be dealt with in terms of the GCR's and Art 9 of these regulations. Refusal to submit a kart for scrutiny as directed shall result in automatic exclusion from the entire event and further disciplinary action. Any part found not to comply with the regulations, and which is incapable of being brought back into specification in a permitted manner, will be confiscated by the organisers to prevent its continued use.

SECTION E

10. COMPETITORS – ENTRANT REQUIREMENTS

The following regulations are supplementary to the General Competition Rules of MSA.

The provisions of GCR 22 notwithstanding, in karting should a parent or court appointed legal guardian not be in a position to act as the entrant for his or her minor child, he or she may nominate another parent/legal guardian whose minor child is taking part in the same event/s or, alternatively, an adult competitor taking part in the same event, to act as his/her entrant by proxy. To be valid, any such proxy nomination must be submitted, in writing and signed by the parent/legal guardian appointing the proxy, to the Race Secretary for the relevant event/s prior to the commencement of competition.

An adult competitor may appoint another adult competitor competing in the same event to act as his/her entrant. Subject to what is set out below in order for that appointment to be valid, that appointment must be submitted in writing recording the reasons for the appointment and signed by the adult competitor appointing another adult competitor to act on behalf of his/her behalf to the Race Secretary for the relevant event prior to the commencement of the event.

For the purposes of this Regulation, an adult competitor excludes any person/s or body deemed to be a competitor (as envisaged in GCR 19) as a consequence of being an entrant in terms of GCR 22.

The Stewards and/or the Clerk of the Course shall be entitled to investigate the reasons why a parent/legal guardian and/or an adult competitor is not in a position to act either for himself/herself or for his/her minor child as an entrant. The Stewards and/or the Clerk of the Course shall in their sole and absolute discretion be entitled to accept and/or reject the appointment of either the third party nominated to act for a minor child or an adult competitor nominated to act for another adult competitor.

It is the entrant's responsibility to ensure that all persons concerned by his entry observe all the provisions of the code, the technical regulations, and the sporting regulations.

The person having charge of an entered kart during any part of an event is responsible jointly with the entrant and/or separately for ensuring that the provisions are observed.

Entrants must ensure that their karts comply with the conditions of conformity and safety throughout the event.

The presentation of a kart for scrutineering will be deemed an implicit statement of conformity.

Entrants, drivers, assistants, and guests must always wear the appropriate identification credentials which have been provided to them.

11 LICENCES

a) New Club and Regional licences holders are recommended to wear a prominent cross on the back of their helmets for three events in a colour contrasting with that of the helmet to warn other competitors.

b) TYPES OF LICENCES

- Club licence - A Club licence is only valid for events of club status.
- Regional licence - Valid for all Regional and Club events.
- National licence - Valid for all National, Regional and Club events.
- International Licence - Issued by MSA as per the CIK regulations as point c below.

c) **FOR INTERNATIONAL COMPETITIONS ONLY**

Junior competitors younger than 12 years of age, who will compete in any CIK/FIA ASN affiliated International/National Championship events, will need to comply with the following requirements in order to apply for their MSA National licence and Start Permission:

- First serve a period of probation with a National Karting Licence and must also be observed to compete satisfactorily in at least 5 ASN-sanctioned karting races within the two years prior to application.
- Undergo a medical aptitude exam during which the height and weight of the Driver must be recorded.

Competitors aged 12 years and over who will compete in any International CIK/FIA Karting Championship or CIK/FIA ASN affiliated International /National Championship events will comply with the 2022 CIK Sporting Regulations in order to apply for their MSA International licence and Start Permission:

International Grade G, for Junior categories, for Drivers between 12 years old (reaching their 12th birthday during the calendar year) and 14 years of age (reaching their 14th birthday during the calendar year). In order to qualify, applicants must:

- First serve a period of probation with a national karting Licence and must also be observed to compete satisfactorily in at least 5 ASN-sanctioned karting races within the two years prior to application
- Undergo a medical aptitude exam performed by an ASN-authorized doctor during which the height and weight of the Driver must be recorded.
- Additionally a Driver's weight (including the Driver's equipment) must be a minimum of 35 kg at all times during a competition

International Grade F, for Senior categories (only non-gearbox categories), for Drivers between 14 years old (reaching their 14th birthday during the calendar year) and 15 years of age (reaching their 15th birthday during the calendar year). In order to qualify, applicants must:

- First serve a period of probation with an International Karting Licence and must also be observed to compete satisfactorily in at least 5 ASN-sanctioned karting races in the Junior category within the two years prior to application
- Undergo a medical aptitude exam performed by an ASN-authorized doctor during which the height and weight of the Driver must be recorded.

International Grade E for Drivers reaching their 15th birthday during the calendar year in which the Licence is issued (over 18 years old for Superkart Drivers).

- First serve a period of probation with a national karting Licence and must also be observed to compete satisfactorily in at least 5 ASN-sanctioned karting races within the two years prior to application
- First serve a period of probation with an International «G» or «F» Karting Licence and must also be observed to compete satisfactorily in at least 5 national and/or international Competitions during the 24 months prior to his application.

In order to preserve the qualification for a «E» Licence, the Driver must participate in at least one International Competition of the appropriate category per 2-year period. Failing what, he must again meet the conditions of the CIK Appendix B.

d) AGE LIMITS AND SPECIFIC CLASSES -

Bambino – National Championship

Open to all drivers from the year of their 5th birthday, to 31 December of the year in which their 9th birthday occurs. From 2023 the age will be lowered to the year of their 8th birthday.

Kid Rok - National Championship

Open to all drivers from the year of their 6th birthday, to 31 December of the year in which their 10th birthday occurs.

Mini Rok – National Championship

Open to all drivers from the year of their 8th birthday, to 31 December of the year in which their 13th birthday occurs.

OKJ – National Championship

Open to all drivers from the year of their 11th birthday, to 31 December of the year in which their 15th birthday occurs.

KZ2 – National Championship

Open to all drivers from the year of their 15th birthday.

KZ – Interprovincial Championship

Open to all drivers from the year of their 26th birthday. Dispensation can be applied for by a “Competitor” who is under the required “Age” of this class, based on personal weight that places them at a disadvantage from competing fairly in the lighter Shifter class. (The application, acceptance and agreement is at the discretion of the GP 125 Shifter Association Committee)

KZ Masters – Regional Championship

Open to all drivers from the year of their 38th birthday.

Micro Max – National Championship

Open to all drivers from the year of their 7th birthday, to 31 December of the year in which their 12th birthday occurs

Mini Max – National Championship

Open to all drivers from the year of their 9th birthday, to 31 December of the year in which their 14th birthday occurs.

Junior Max – National Championship

Open to all drivers from the year of their 12th birthday, to 31 December of the year in which their 15th birthday occurs.

Senior Max – National Championship

Open to all drivers from the year of their 14th birthday.

DD2 – National Championship

Open to all drivers from the year of their 15th birthday.

DD2 Masters – National Championship

Open to all drivers from the year of their 32nd birthday.

Drivers of 16 years or older who weigh more than 85kg in their shorts on the day of the race may race in this class

- e) In order to be issued with a licence, competitors must be able to provide proof of current membership of an MSA affiliated karting club. To compete in the KZ, KZ Masters and KZ2 Shifter Classes, it is compulsory to be a member of the GP 125 Shifter Association which is affiliated to MOTORSPORT SOUTH AFRICA.

SECTION F

12 SAFETY CLOTHING

Drivers shall wear, both during official and unofficial practice and during all racing, a properly positioned and secured crash helmet, with splinter proof visor in position. In addition, gloves that cover the hands completely, and a protective one-piece race suit must be worn. Boots and socks must be worn adequate to cover and protect the ankles. For all competitors younger than 13 years of age, suitable neck braces and chest guards are recommended.

- a) SUITS – Karting Suits must have a CIK homologation number or MSA approval.
- b) HELMETS - All drivers must wear a helmet with efficient and unbreakable protection for the eyes. All helmets must comply with the DOT, SNELL, ECE or CMR specifications approved for the following categories of motorsport, Cars, Motorcycle and Karts. All helmets must have chin protection (Full-face helmet). It is highly recommended that drivers of the age 15 and younger use CMR specification helmets.

NOTE: The use of Helmets 10 years after their date of manufacture is not permitted. All labels and markings indicating specifications and date of manufacture must be clearly visible. Event officials may request a competitor to provide proof that the helmet does comply with requirements as set out in this regulation.

Drivers must always secure all loose straps or flaps around the helmet base and neck area, including neck brace and overall straps. If doubt exists with officials as to whether a helmet strap is fastened correctly, then the competitor will receive a black & orange flag. Once the competitor has secured the helmet and /or loose straps then he/she will be allowed to return to the circuit.

13 DRIVERS BRIEFING

If it is stated in the supplementary regulations that a drivers' briefing is to be held prior to the commencement of racing, it is compulsory for all competitors to attend. Failure to attend drivers briefing and not excusing themselves may result in a fine of R1500.00.

14 SAFETY PROCEDURES

- a) ENTERING PITS - It is compulsory for all drivers to stop and cut their engines at the entrance to the paddock areas. Failure to observe this rule may result in a fine of R750.00.
- b) During both practice (unofficial and official) and racing, drivers intending to leave the track to enter the paddocks or pits **MUST INDICATE THEIR INTENTION BY RAISING ONE ARM. THEY MUST LEAVE THE TRACK ON THE SIDE THAT WILL GIVE THEM AN UNINTERRUPTED RUN INTO THE PIT OR PADDOCK ENTRANCE WITHOUT CROSSING THE PATH OF A FOLLOWING KART.**

SECTION G

15 CONDUCT

- a) All persons shall conduct themselves in an orderly manner. Any disorderly conduct or any failure to obey official instructions or any breach of these regulations by entrants, drivers, or their assistants, shall make the entrant concerned liable to a penalty and/or fine.

All participants must play within the rules and respect race officials and their decisions.

- b) All participants must respect the rights, dignity, and value of their fellow participants regardless of gender, ability, physical appearance, cultural background, or religion.

All participants must always encourage and take responsibility for their actions.

- c) All participants must ensure their equipment is safe and race worthy, prior to taking part in training, testing or race events. Only approved racewear (e.g.: helmet, gloves, race boots and suit) to be used by the driver, according to the regulations.

It is the participants own responsibility to identify and measure his/her own skill level against his/her competitors, and take responsibility for the risks associated with training, testing and or racing. It should be noted that a basic level of competence is required.

- d) It is the participant's responsibility to declare, prior to any participation in training, testing, or racing, of any medical condition or medication required that may be relevant in the event of an emergency.

- e) All participants are required to display courtesy and etiquette to other members and participants in training, testing and race events. Any disputes or problems that may arise during an event must be addressed in a respectful manner, to the correct person (official) at the event.

- f) The safety of children within the sport is a priority. Knowledge of the code of ethics surrounding care of children in sports will be promoted and encouraged. It is the participant's own responsibility to ensure the safety of children at training, testing, or racing events.

- g) When taking part in any event, it is the responsibility of the driver to take the time to read and fully understand the posted rules, regulations and conditions for said event prior to start time, thus eliminating unnecessary delays at the beginning of the event. Requests for clarification of these rules, regulations, or conditions, should be asked in the drivers meeting held before each event.

- h) All participants must have respect for the environment and the surrounding inhabitants. Responsibility must be taken to reduce excessive noise and keep all areas that are used as clean and pollution free as possible.

- i) All participants must respect that drugs and alcohol are strictly prohibited at training, testing and races. It is an offence and will not be tolerated. Offenders will be excluded from the event and face further disciplinary action.

- j) Any abusive comments on social media (Facebook, Twitter etc.) between teams, competitors, officials, organizers, will be held responsible and liable for their actions.

- k) If the offence occurs during a race, the kart and driver concerned may be excluded from the race, or entire event and/or a penalty and/or a fine may be imposed. Failure to report at a specified time shall be a breach of the regulations and may be subject to a penalty and/or a fine.

- l) Wild or disorderly driving shall be subject to exclusion.

- m) Any proceeding, derogatory action, or interference with or against a race official by entrants, drivers,

or their assistants shall be considered a breach of GCR 172 (iv) and shall make the entrant liable to a penalty and/or a fine. (Refer to GCR 121 for the definition of responsibility).

- n) Abuse of officials – refer GCR 172 (x).

16 DESIGNATED REVVING AREA

To avoid excessive noise and exhaust emissions revving the engine in the servicing park is not allowed (except a short function test – 5 seconds maximum)

Competitors are advised that organizers and officials will now strictly enforce this regulation and to accommodate those wishing to “REV” or warm up their engines the following points will apply:

- a) “Servicing park” is defined as any area or surrounding the pits, access roads, parc ferme’ or pre-race grid.
- b) Each circuit will have a defined “REVVING” area, and this will be the only place where tests of longer than 5 (five) seconds are permitted. This area will generally be in the pre-race area of the circuit.
- c) A fine of R500.00 for a first offence will be imposed for any breach of these regulations. Any subsequent transgressions will be penalised at the discretion of the race officials.
- d) A statement from any signed on official of the event is the only evidence required for the imposition of a penalty.

SECTION H

17 WITHDRAWAL FROM AN EVENT OR RACE

Refer GCR 110.

18 FIRE EXTINGUISHERS

Each competitor shall be required to present a dry powder fire extinguisher at pre-race scrutiny. The extinguisher must be of at least 1,5kg capacity and be marked in a permanent fashion with the competitor’s name and competition number. It must bear evidence of having been serviced within the previous 12 months.

19 FLAGS

Flag signals will be per Appendix H and in addition

- a) A green flag with yellow chevron will be used to signal a false start. This flag will be situated at the marshal post at Turn 1 after the start. It will be waved at the instruction of the Chief Marshal.
- b) A green flag may also be used, if necessary, to signal the start of warm up laps, or the start of practice sessions by order of the Clerk of the Course. It is not obligatory that this flag will be displayed after showing the yellow flag to indicate the track is clear of any dangerous situation, provided the supplementary regulations state that the green flag will not be displayed in such situations.
- c) A blue flag with red diagonal crosses used in conjunction with a signal board displaying a competitor’s number, will signify that the competitor must stop as he/she has been lapped or is about to be lapped.

20 TIMEKEEPING AND TRANSPONDERS

Only timing systems approved by the MSA Karting Management Group may be used for all karting events.

- a) Competitors at SA National and Regional Kart Racing Championships need to supply their own

transponders (whether purchased or rented). Transponders will not be supplied by the organisers. Competitors MUST ensure their own transponders are properly charged and fitted by the 3rd practice session of a SA National Championship event. Timekeepers are not responsible for unrecorded times, particularly due to low battery transponders.

- b) Competitors at Club events will not be required to have their own transponders.

21 VEHICLES - GENERAL

- a) All karts must satisfy the Scrutineers and Technical Consultant of the meeting as to their suitability for racing, considering all details of their design and construction. In addition, it must be evident, both from a static examination and from its behaviour on the track, that a kart will present no hazard to the driver or to other competitors or to spectators. Checks may be carried out at any time to ensure that only permitted chassis are being raced.

- b) **ADDITIONAL REQUIREMENTS FOR KARTS COMPETING OTHER THAN AT KART TRACKS**

MSA may permit karts to compete on a course used for other types of racing and speed events having different rules and regulations. In such a case the MSA Scrutineers of the Meeting shall be satisfied that in addition to complying with MSA kart specifications above, and further requirements hereafter, the design and construction of the karts and their accessories are suitable for the event particularly in respect of strength.

When competing in such condition's karts shall be exempted from complying with MSA vehicle regulations for cars, provided the MSA Scrutineer is satisfied with the soundness of the general construction of the karts. Stub axles and steering components shall be of adequate strength and proper design.

Karts shall be fitted with adequate brakes on at least both rear wheels. Tyres of an industrial type shall not be used. In addition, the handling and steering characteristics of all karts shall be such, in relation to the course, that no hazard is created.

22 RACING NUMBERS

Each kart shall be identified prior to scrutineering by opaque flexible plastic number plates affixed to the kart itself and facing front and to the rear.

- a) **Bibs & rear bumpers:**

Classes less than 99cc engine capacity	-	10cm (100mm) minimum
Classes greater than 100cc engine capacity	-	14cm (140mm) minimum

ALL ROK CLASSES

Black numbers displayed on yellow backing only will be allowed

ALL ROTAX CLASSES

Bambino	1 to 99	Black number yellow backing
Micro MAX	601 to 699	Black number yellow backing
Mini MAX	501 to 599	White number blue backing
Junior MAX	401 to 499	White number green backing
Senior MAX	201 to 299	White number black backing

DD2	1 to 99	White number red backing
DD2 Masters	101 to 199	Black number white backing

The numbers must be standard font "ARIAL" and in an unbroken colour without borders, edging or shadow. For TV coverage, marketing and timekeeping purposes, all race numbers must be bold upright (no italics) ARIAL font. Script type numbers are not permitted. Neither neon coloured numbers and or backgrounds are permitted.

- b) Competition numbers must be present and legible on the side pods in the same upright bold fonts as above. The backing on for these side pod numbers can be either the standard yellow or the class colour. No other colours are permitted. For TV & marketing, the recommended size for these side numbers is 80mm.

- c) NUMBERS 1 -10

The first 10 Racing Numbers in each class eg: 401 to 410 will be reserved for the top ten finishers in the previous year's SA Championship for the class. All racing numbers shall be allocated by and be obtained from MSA on a first come first served basis. Consideration will be given to competitors who actively used the number in the previous season. Numbers not reserved by the first National race of the season will automatically be released. Numbers will not be reserved for non-MSA licence holders. All foreign competitors entering MSA sanctioned events must ensure the number is available on an event to event basis. Should a competitor move up a class the number he/she had the previous year will not always be guaranteed for use in the new class.

SECTION I

23. PRACTICING

On each day of an event, before racing commences, a definite period or periods shall be allotted for practicing.

- a) For club and regional championship events, the minimum free practice time shall be one 5-minute session, for each class. All regulations and requirements applicable to racing except for the starting procedure, shall apply to practice.

Should an event be run over two days, free practice on the second day may be substituted by qualifying.

- b) Each driver shall complete at least three laps continuous running in practice at each meeting before taking part in a race. The COC can waive this requirement for an experienced driver
- c) Classes shall generally practice separately but classes of similar performance may be grouped together where deemed necessary. The proviso in this regard is that the number of karts shall not exceed the maximum permitted for the track. Refer also Sec C - 8 a)

24 RACING – GENERAL REGULATIONS AND FORMAT APPLICABLE TO ALL COMPETITIONS

- a) In the interest of safety, before a kart proceeds onto the track for timed laps or races, a check shall be made that it has been passed by the Scrutineers.
- b) Only the officially nominated driver shall drive a kart on the track during pre-race practice and racing, except with the specific permission of the Clerk of the Course.
- c) Methods for starting shall be:
- i) A rolling start for non-gearbox classes, except for Bambino Class, where a standing start is an option

- ii) A standing start, with engines running, for gearbox classes. Organizers may use a rolling start provided this is clearly laid down in the SR's for the event. **(A 'Le Mans' type start is prohibited).**
- d) The Organisers reserve the right to start the Bambino class under 'Pace Kart' conditions where a Pace Kart will be utilised for this purpose. Such must appear in the event SRs.
- e) For all classes, the karts will be assembled in 2 parallel rows.
- f) The order in which the karts shall be started will be determined by:
 - i) Ballot,
 - ii) Qualifying, which shall consist of either a 10-minute practice session where each lap is timed for every driver or, alternatively, two timed laps preceded by a warm-up lap for each driver, i.e. 1 warm up & two flying laps. The time of each driver's best lap will count for grid position, the second-best lap time being used to separate any possible ties.
- g) The fastest time set in a preceding heat may determine the grid for the subsequent races
- h) Any driver deliberately jeopardizing another driver's lap time will be penalized accordingly.
- i) Qualifying and starting grids may be defined in the individual class-specific regulations.
- j) In respect of the 10 minute timed session, drivers who stop or spin off and cannot restart themselves and who, at that stage have not recorded three timed laps may apply for extra timed laps – **at the COC's sole discretion.**
- k) In the above case (timed session), approval of the application for additional timed laps will be at the sole discretion of the Clerk of the Course.

Note: Where qualifying is based on the "10minute session" method, a re-run granted will only consist of one warm-up and two-timed laps
- l) Karts to be used for a re-run must remain in Parc Ferme between runs under the supervision of a scrutineer, i.e. no work may be carried out between runs.
- m) The method of determining grids must be published in the relevant championship regulations and/or event SR's.
- n) Each kart will be allocated a starting position on the pre-race grid. The places of non- starters will be left empty, the other competitors retaining their allocated positions.
- o) Protests regarding start positions must be carried out in accordance with Part IX of the MSA Handbook.
- p) Pole position will be on the side of the track corresponding to the inside of the first corner after the start.

25 ROLLING STARTS

On display of the green flag indicating that karts are under starter's orders, the karts will leave the pre-race paddock and proceed in two parallel rows in grid order directly to the 90 metre steady speed point (see below) or complete a lap or part thereof as instructed by the Clerk of the Course depending upon the nature of the circuit or the size of the field.

No further karts will be allowed out of the pre-race paddock onto the circuit once the start signal has been given and the race has begun.

A steady speed point must be indicated by a RED line and/or markers on either side of the track at a suitable point (within the ambits of the circuit). But not less than 90 meters before the start line, and

when the pole position driver reaches this point, he must set and maintain a reasonable and constant speed slow enough to allow the field to form and bunch up and the driver in No 2 position must at this stage without delay position himself level with the pole driver.

The rest of the field must then bunch up in their allocated positions behind the two leading drivers, in two parallel lines. A driver, who is unable to take up his correct grid position prior to the field reaching the 90 meters' steady point, must take up position at the rear of the field.

The No 2 driver must maintain position level or slightly behind the pole driver as they approach the start line. At any point between the 25-meter line and the start line, when the two leading karts are level, or the pole man is slightly ahead and the majority of the field (generally the first 10 karts) is in position, well bunched up and in two parallel lines, the starter may give the starting signal. Until the signal to start is given the entire field will remain in grid order one behind the other and it is forbidden to move either to the left or the right or leave more than one kart length behind the kart in front.

Should the Starter or the Clerk of the Course not be satisfied with the disposition of the field as the leading karts approach the start line, it may be indicated that the field must complete another warm up lap, or a false start may be notified to the drivers by means of showing the false start flag (green with yellow chevron).

Drivers will then proceed round the circuit and repeat the starting procedure. Should the start signal have been given and the race has in fact begun, then any competitor guilty of a starting offence may be penalised and will be notified accordingly after the race.

The onus is on each competitor to ensure that he/she complies with the starting procedure. In the event of the pole driver not being able to take up his correct position, the No 2 driver will be responsible for setting the pace from the Red 90-meter steady point. If either of the front row grid positions are vacant as the field approaches the start line, then the starter may start the race based on the position of the remaining front row kart(s) alone.

Note: Any penalty imposed as a result of the above, must be advised to the competitor after completion of the race or heat and must be deducted immediately from the driver's accumulated points for the day following a hearing.

26 STANDING STARTS

On display of the green flag, the karts will proceed at an orderly pace to the dummy or starting grid where they will stop in either staggered or parallel formation as defined in the SR's with engines running and in their allocated positions when the Clerk of the Course will signal the starter to start the race.

Any movement of the kart during the starting procedure (movements while the red lights are on) that is evaluated as a false start will be punished with a minimum 5-place penalty.

If a Driver is unable to start, he must remain in his kart and notify this situation by raising his arm. In this case, an additional Formation Lap may be granted; any Drivers who have been unable to start will be allowed to get out of their karts and restart only by their own means or assisted by a Marshal and once the whole field has passed them. They will not be authorised to regain their original position in the formation and will take the start from the back of it.

No other Drivers will be allowed to occupy the places which have remained vacant. During the Formation Lap(s), it is forbidden to practise start simulations.

If it is necessary to interrupt the starting procedure, the Clerk of the Course will show a waved red flag, indicating to the Drivers that they must cut their engines.

Should the Clerk of the Course be dissatisfied with the disposition of the field for any reason he may send them round for another lap after which they will reform again on the grid.

A place penalty of 5 places for the first offence, then 8 places for the second offence and then exclusion for the third offence shall be imposed by the Clerk of the Course, should any of the following actions occur which will be classed as starting offences should the start signal have been given:

Starting further forward than the allocated grid position or ahead of the demarcated line.

The imposition of a penalty as a result of the above must be advised to the competitor after completion of the race or heat, and the race results must be immediately amended accordingly to allow the driver's accumulated points for the day to be calculated correctly.

27 SIGNAL TO START A RACE

A race shall be started by the lowering of the MSA flag or alternatively by the extinguishing of the red light/s. In the latter case, a red light/s must be mounted directly above the circuit and must be visible from any point on the starting grid.

Illumination of the red light will correspond to the raising of the start flag, being followed by extinguishing of the light/s to start the race. In the use of flag starts, the starter may be positioned beside the track but may not start the race from any position upon the tarmac of the circuit.

It is obligatory to state in the supplementary regulations if lights are to be used. In the case of a false start, the Clerk of the Course may have the field return to the pre-race paddock and penalise the guilty driver accordingly.

Should the Clerk of the Course allow the field to reform for another lap and a starting offence is again committed, the race will continue, and the guilty party shall be penalised accordingly after the end of the race. Should a penalty be imposed, that penalty will be a place penalty of 5 places for the first offence, then 8 places for the second offence and then exclusion for the third offence.

Any penalty imposed as a result of the above must be advised to the competitor with a hearing after completion of the race or heat and the race results must be immediately amended to allow the driver's accumulated points for the day to be calculated correctly.

28 SIGNAL TO FINISH THE RACE

It shall be obligatory for the chequered flag to be shown after the last lap board. After receiving the end of the race (or practice) signal, which shall be the displaying of the chequered flag, each driver shall continue at a reduced speed to the paddock entrance.

If, during a race, the chequered flag is inadvertently displayed before the race is scheduled to end (in terms of the SR's or as amended), the race will nevertheless be deemed to have ended.

If, during a race, the chequered flag is inadvertently displayed after the race is scheduled to end, the race will nevertheless be deemed to have ended when it was due to end.

29 CLASSIFICATION OF A FINISHER

After the winner has received the chequered flag, any driver who has not completed the full number of provided laps, even if he does not finish the race, will be classified according to the number of laps he has actually covered, provided he has completed at least two thirds (67%) of the race distance (rounded down to the nearest whole number of laps). No kart may be pushed over the finish line. For the resolving of Ties refer to point 38

30 REFUELING

Refuelling during a race is forbidden, unless permitted by the Supplementary Regulations. Whenever a

kart is refuelled at the pits, the engine shall be stopped throughout the refuelling operation, and the driver shall vacate his kart. No entrant shall have any one container in the pits holding more than 25 litres of fuel.

31 STOPPING THE RACE

Should it be deemed necessary to stop the race due to an accident on the grounds of safety or for any other reason, the RED FLAG shall be shown by the Clerk of the Course and all flag Marshals shall show red flags to indicate the race has been stopped.

All drivers will immediately stop racing and continue slowly to the start line, being prepared to stop at any point if requested to do so by an official. On reaching the start line, the competitors shall be required to stop. The results will be formulated as follows:

- a) Should less than two (2) laps have been completed the race shall be re-run and the first start declared null and void. Only the original drivers will be entitled to take part in the restart, and they will take up their original start positions. The restart time will be at the discretion of the Clerk of the Course.
- b) Should the race be stopped between laps three (3) and 67% of the total race distance, the race will be restarted based on the finishing order of drivers the lap preceding the stopping. The restart time, if delayed, will be at the discretion of the Clerk of the Course.
- c) Should 67% have been completed it shall be deemed a race and the result will be the finishing order at the end of the lap preceding the stopping.

32 TELEMETRY/DATA LOGGING/RADIO COMMUNICATION

Any form of telemetry or radio communication with the kart or driver, while they are in motion on the track, is prohibited, during official practice, qualifying and races. However, data logging for the purpose of later downloading as specified in the regulations only is permitted.

33 ON BOARD CAMERAS

Competitors wishing to carry on-board cameras or any race recording devices:

- a) Recording devices (Go-Pro's) may only be mounted with the standard brackets (as supplied with the unit) to the kart's plastic side pods, nose cone and rear bumper or bib and on top of the radiator. No additional mounting extension between the kart and the recording device is permitted.
- b) A maximum of two recording devices is allowed per kart. It is NOT permitted to mount any device on the outside of helmet.
- c) Ensure these are adequately and securely fitted to their karts for inspection at scrutineering and at any time during an event.
- d) Declare their intention to use a camera on their entry form.
- e) Make available all camera footage to officials on demand

34 WEIGHING SCALE

The weight of the karts shall be adjudged as they crossed the finish line at the end of the practice session or race, i.e. any part lost off the kart after the finish line may be weighed together with the kart.

- a) It is compulsory after qualifying and after each race for all drivers and their karts in all classes to be weighed prior to entering the Parc ferme paddock. The penalty for being underweight is exclusion.
- b) Scale of the day will be the instrument to be used. Refer Sec B 5 – g)

THE DISPLAYED WEIGHT IS THE ONLY NUMBER CONSIDERED – NO TOLERANCE OR LATITUDE IS TO BE

GRANTED BY SCALE ATTENDANTS

- c) Karts MAY NEVER be driven onto the scale and must always be pushed.
- d) A kart will only be weighed once, and the weight recorded accordingly. Should a competitor be under weight, the kart and driver in question will be asked to stand in a quarantined area with no outside interference. Failure to comply with this requirement will result in exclusion. The competitor will be given the opportunity to weigh again twice more, after all other karts have been weighed.
- e) If a component falls of a kart e.g. Side Pod, rear bumper etc. the driver or official may retrieve the part as long as it is safe to do so prior to proceeding to the scale. If the driver does not retrieve the item prior to going to the scales the weight of the kart will be taken as is and recorded as such.

35 RECOVERY

In case of a breakdown no outside assistance will be allowed except by the designated recovery vehicle.

36 OUTSIDE ASSISTANCE

No driver may receive outside help from any person other than a marshal or race official on the track once the karts have left the pre-start grid for the start of a race.

Drivers may, however, during the race, enter the pits by the proper method, weigh the kart, receive assistance in the pits and then re-join the race.

- a) The only exceptions to the rule regarding assistance on the track are:
 - i) Marshals may assist drivers who have come to a stop to place a kart off the circuit to avoid obstructing other competitors.
 - ii) The starting of engine
 - iii) s or pushing of karts is only permitted by the driver concerned when it is deemed safe.
 - iv) Bambino competitors may receive outside assistance with the permission of the Clerk of the Course from a limited number of identified parents/pit crew who have been given an introductory marshalling course and are registered as Officials with visibility vests, and signed indemnities.
 - v) These Officials must assist all Bambino drivers and not only their own children, otherwise they will no longer be permitted to assist on track
- b) From the commencement of the official qualifying practice only authorized officials are allowed on the track. The penalty for receiving outside assistance, whether the assistance is solicited or not, unless it is an authorized race official, is automatic exclusion from that race or qualifying.
- c) Where a circuit has provision for a demarcated area for repairs to karts which does not require karts to cross the scale, competitors may make use of this area DURING RACING ONLY without the necessity of first crossing the scale. The location of the said demarcated area must be made known to competitors at drivers briefing and karts entering this area for repairs must come to a complete standstill prior to returning to the race circuit.

SECTION J

37 VARIATION OF REGULATIONS

Any variation of these regulations approved by MSA will be advised by means of issuing Versions of the Standing Supplementary Regulations or MSA bulletin for each event affected by such variation.

38 POINTS SCORING

- a) Competitors found guilty of an infringement, resulting in exclusion, will score zero (0) points and can

be used as dropped points. Exclusions as a result of a technical infringement will score zero (0) points and cannot be used as a dropped point. The competitors 10 out of 13 heats from the 4 championship rounds will count towards the final championship standings. The competitors worst three heats will be used as dropped points.

- b) In the event of a tie having to be resolved to declare a winner, preference will be given to the competitor having the greatest number of first places. If a tie remains, the greatest number of second places, failing this third places, and so on, will be considered. Should there still be a tie; the competitor having the highest score in the last race shall take preference.
- c) In the event of tied competitors not being classified in the last race, then the previous race's finishing order will be taken into account, and so on until the tie is resolved.
- d) Points will be allocated as follows based on finishing positions - 35, 32, 30, 29, 28 and so on. Non-finisher 5 points less than lowest placed finisher. A finisher will be deemed to have completed more than 67% of race distance.
- e) Club and Regional Events: - scoring is according to the relevant regulations governing the individual championships.

SECTION K

39 SA NATIONAL CHAMPIONSHIPS

The aim of the Championship will be to declare a SA National Karting Champion in the following classes provided that a minimum of 6 starters per class per event have been met:

Bambino, Kid Rok, Mini Rok, OKJ and KZ2. Mini Max, Micro Max, Junior Max, Senior Max, DD2, DD2 Masters.

- b) The MSA Karting Management Group reserves the right to review for the following year the national championship status of any class that fails to comply with the minimum requirements. Refer also Sec C 8 a). Also refer to GCR 230 & 266
- c) **Circuits will be closed to all national competitors and equipment to be used in the National Championship event, from the Monday, immediately preceding the start of practice as per the event programme.** The Championship will be run over four (4) rounds with 13 heats in total. The first three rounds will have three heats on the day. The fourth round will have a total of 4 heats on the day. All events will take place over a maximum of three days (including the half day open practice).
- d) Race distance per National Championship race shall be prescribed by class-specific regulations in line with:
 - Bambino Minimum 8km & Maximum 10km
 - KID Rok - Minimum 8km & Maximum 12km.
 - Micro Max, Mini Rok/Max: - Minimum 10km & Maximum 15km
 - KZ & KZ Masters – Minimum 12km & Maximum 25km
 - All other classes: - Minimum 15km & Maximum 25km
- e) Series Prizes
Kid ROK
The 1st place overall competitor at the end of the championship, will be awarded the qualified drive, to attend the ROK international Final. All costs to attend the final will be for the competitor's own account. Should a competitor not be able to attend the event, the ticket will be awarded to the second place overall competitor and so forth.

Should the driver be 9 years or older at the time of the event he/she will be awarded a qualified drive in the ROK International Final in the Mini ROK class in lieu of the above.

Should the competitor be younger than 9 years old they will win a new Mini Rok engine.

Mini ROK

The 1st place overall competitor will be awarded the qualified drive in the ROK International Final in the Mini ROK class. All costs to attend the final will be for the competitor's own account. Should a competitor not be able to attend the event, the ticket will be awarded to the second place overall competitor and so forth.

The 1st place overall under 10, will be awarded ~~the qualified~~ a wild card drive in the ROK International Final in the Mini ROK class. The under 10 driver needs to be 9 years old at the time of the event to make use of the seat.

OKJ

1st place, will be awarded the qualified drive in the ROK International Final in the Junior ROK class, provided said driver is age eligible, failing that it will be awarded to the highest placed eligible driver. Highest finishing driver eligible by means of being between the ages of 12-14 the following year, will be awarded the Seat for the FIA karting academy trophy. Should a second seat become available or the top finishing driver are not able to attend the next eligible driver will get the seat. ** Note that the seat belongs to the ASN and MSA and in conjunction with the winning competitor makes the necessary arrangements regarding registration etc. Competitors who are awarded the seat should ensure that they are financially able to attend the Academy.

KZ2

1st place will be awarded the qualified drive in the ROK International in the ROK Shifter class.

KZ

1st place will be awarded a wild card seat in the ROK International in the ROK Shifter class.

ROK Cup International Final

In addition to the stated prizes above possible Wild Card seats are available for the World finals to drivers that have competed in minimum 6 ROK Events, 3 of which is required to be ROK Cup SA events, during 2022. Participation in WSK, FIA or ROK Cup events internationally will be taken in consideration.

Prize money will be awarded to the top 3 finishers in each class except Mini Rok U10 at each National event:

First Place R3500 Second Place R1500 Third Place R1000

Mini Rok U10 - First Place R3500

No prizes will be available for Bambino or Rotax Classes.

40 EVENT FORMAT

Refer to the event Supplementary Regulations

41 OBSERVATION FORM

Completion of this form within 30 minutes of observing an incident serves to bring an issue to the attention of the senior race officials at an event.

- a) It shall not replace a formal protest and the race officials shall not be obliged to act on its contents.
- b) Forms will not be accepted after 30 minutes of the incident occurring.

- c) Any competitor who considers himself/herself sufficiently aggrieved, and requires an issue to be formally investigated, is advised to rather lodge a formal protest/appeal as per the relevant GCR's within the stipulated time limits.

42 PROTESTS

Refer to Part IX of the GCR's.

43 APPEALS

Refer to Part IX of the GCR's.

- a) Where a formal appeal (following a protest) arises as the result of exclusion in terms of a contravention of the technical regulations and specifications, the part/s under dispute will be impounded by the relevant officials, sealed and submitted to MSA Head Office.
- b) Should notice of intention to appeal not have been timeously lodged in terms of the regulations, and the part/s are therefore not impounded, late acceptance of such appeal shall not be considered or granted.

SECTION L

44 KARTING SPECIFICATIONS – GENERAL

- a) All Karts are to be raced as supplied, other than as listed below or as stated below for clarification where necessary.
- b) In the event of anything that is not covered either in the published homologation documents which are available on the MSA website, then the general chassis specifications as they appear on the CIK website will apply. This is applicable to ALL chassis including those 750mm to 950mm chassis homologated by the Italian ASN (ACI) or by Motorsport South Africa (MSA).
- c) Detail references can be found on the CIK website and should be used only when not referenced in these regulations.

45 CHASSIS

Only homologated chassis as per Appendix A may be used.

Technical details of the permitted race equipment are detailed in the class-specific regulations.

SECTION M

46 HOMOLOGATION

Homologation is the identification of equipment or materials used for the purpose of competition in kart racing. It is an official certification made by MSA that a chassis or engine or type of specifically designed equipment has been made and is freely available in sufficient numbers to justify being sanctioned for racing in one or more class.

- a) Classes are classified either **restricted** (where only one or two make/models of engine and/or chassis are permitted) or **unrestricted**.
- b) Where classes are restricted to one or two chassis or engine makes/models or one make/compound of tyre, MSA may impose a maximum retail-selling price for this equipment (including spares) based on the prices, increases and exchange rates submitted by accredited dealers when making application for

homologation of this equipment. MSA may permit any set maximum retail selling prices to be adjusted on application from the supplier based on unusual circumstances or unusual variances in the exchange rate.

47 CHASSIS TYRES AND ENGINES

Applications for homologation of engines, tyres and chassis, to be used in any class, regardless of the status of that class will only be accepted from MSA-accredited importers and karting dealers.

- a) MSA Karting Management Group shall be entitled to terminate the existing homologation of any engine, tyres or chassis with a minimum of one calendar year's advance notice to competitors.
- b) The MSA Karting Management Group shall have the right to invite new applications for engines, tyres and chassis homologation at any time. Each homologation period is valid for a one year period unless otherwise specifically stated. Should an importer have applied for engines or tyres homologation in the previous 3-year moratorium cycle, after the 3 year cycle has ended, the homologation will continue on an annual basis.
- c) Chassis identification for homologation purposes is by either its CIK homologation document or under a similar MSA homologation document number where no CIK document existed at the time of original MSA homologation.

NOTE: Applications for the homologation period will only be considered for chassis having CIK homologation or locally manufactured chassis/brands to be homologated through MSA, or another ASN in the case of chassis for use by competitors under the age of 13 or having Rotax approval in the case of the DD2 class.

- d) Once an engine has been homologated for a class then any changes during that homologation period, be they upgrades, or replacements are only allowed, provided they fit into the norms and standards for that class and provided they conform to any new International Technical Specifications issued by the manufacturer.
- e) A notice period of 90 days may be given to competitors before implementation. Single engine classes must remain exactly that – one engine make formulas. The standard one year homologation cycle continues in all other regards.

48 HOMOLOGATION OF LOCALLY MANUFACTURED CHASSIS

The following requirements must be met:

- a) Produce 10 identical complete chassis of the same model, plus 5 complete chassis for Spares.
- b) Brake system to be CIK approved.
- c) Bodywork must be CIK approved.
- d) All chassis models to have specification drawings as per CIK regulations.
- e) Any changes in design during the homologation period must be within CIK permitted rules.
- f) All chassis must be clearly marked with a homologation plate that conforms to the CIK rules.
- g) All rims to be CIK approved.

49 HOMOLOGATION PROCEDURE

a) ENGINES: - Engines will be homologated on an annual basis 1 January – 31 December

- i) Applications for renewal of homologations for engines must be made no later than **31st May** of the year preceding each new homologation period. For renewal of an existing homologation for an engine the fee is payable on application as per Art 49 d ii. No inspection is required.
- ii) All new engine homologation applications must be submitted to the Karting Management Group by no

later than the **31st of March** of the year preceding the homologation period. The following documents must be submitted with the homologation application:

- A completed homologation application form available from msa@motorsport.co.za
- Proof of payment of the application fee refer Art 54 d ii.
- Engine Specification Sheets

Once interim approval has been granted by the Karting Management Group the following process will must be complied with:

- The importer must provide documented proof of having imported 5 units plus adequate spares.
- Once the engines been imported, an inspection will be carried out by the Technical Delegate of the Karting Management Group.
- Final approval will be subject to compliance of the inspection, as well as payment of the Homologation fees as in Art 54 d ii.

b) CHASSIS: - CIK Chassis brands will be homologated on an annual basis 1 January – 31 December. This applies to new applications and renewals.

i) All new chassis homologation applications must be made to the Karting Management Group before 30 September of the preceding year. The following documents must be submitted with the homologation application:

- A completed homologation application form available from msa@motorsport.co.za
- A letter of appointment as a distributor from the Chassis Manufacturer
- Proof of payment of the application fee as per Art 49 d iii.
- CIK homologation documents

ii) Once interim approval has been granted by the Karting Management Group the following process must be complied with:

- The importer must provide documented proof of having imported 10 complete chassis and the required spares package of R1 000 000.00
- Once chassis and spares have been imported, an inspection will be carried out by the Technical Delegate of the Karting Management Group.
- Final approval will be subject to compliance of the inspection, as well as payment of the Homologation fees as in Art 54 d iii.

iii) All existing brand renewal will need to provide proof of as a minimum of 5 new chassis imported per annum, 1 January to 31 December for each year. This proof must be submitted to the Karting Management Group by the 30 November each year.

iv) MSA reserves the right to extend the homologation of any specific CIK brand chassis previously homologated, in the absence of an application from an accredited dealer.

- v) All chassis entered and raced must be presented as the approved brand for the chassis homologated, it may not in any form or guise appear or be presented as any Non MSA/CIK approved chassis brand.
- c) **BAMBINO, MICRO AND MINI CLASSES**
- i) For new engines not presently homologated for the Bambino, Kid Rok, Micro, or Mini Max Classes in such cases, one example of an engine or chassis must be submitted for inspection together with a list of retail prices plus increases for the period of homologation for the complete engine or chassis as well as all spare parts.
- ii) In addition, all technical specifications and drawings must be submitted.
- iii) If acceptance of the application is granted, final homologation will only be granted once a total of 15 engine units plus adequate spares has been made available for inspection (including the original).
- iv) The fee is **R3000.00** (excl. VAT) plus inspection costs upon inspection for engines.
- d) **SUMMARY OF HOMOLOGATION FEES,**
- i) **TYRES: -**
- | | |
|--------------------------------|---|
| Homologation Application Fees: | R3000.00 excl VAT per brand and compound |
| Homologation Testing Fees: | R3000.00 excl VAT per brand and compound |
| Homologation Approval Fee: | R3000.00 excl VAT per brand/compound plus R3000.00 excl VAT per class |
| Homologation Renewal Fees: | R1000.00 excl VAT per class annually |
- ii) **ENGINES: -**
- | | |
|-------------------------------|---|
| Homologation Application Fee: | R3000.00 excl VAT |
| Homologation Inspection Fee: | R3000.00 excl VAT, per make/model, plus expenses |
| Homologation Approval Fee: | R3000.00 excl VAT per class |
| Homologation Renewal Fee: | R1000.00 excl VAT per class annually |
- iii) **CHASSIS:- NEW APPLICATIONS ONLY**
- | | |
|--------------------------|---|
| Homologation Application | R5800.00 excl VAT per brand |
| Homologation Inspection | R5800.00 excl VAT per brand, plus inspection costs |
| Homologation Approval | R5800.00 excl VAT, per brand |
- (iii) If an Importer/Dealer fails to pay the homologation renewal fees by 28 February during the homologation year. A late penalty fee of R5000.00 will be added to the original amount. If the amount has not been paid by 1st April, the relevant homologation will be withdrawn and the dealer/importer will be removed as an importer and will not be allowed to apply for a new homologation of a chassis, tyre or engine for a TWO year period. Should a homologation be withdrawn, competitors will be allowed to race under private homologation for a minimum of one year.
- e) **HOMOLOGATION FOR PRIVATEERS -** In the event of no accredited dealer making an application to extend the homologation of an engine/or chassis homologated for the previous period nor MSA extending its homologation, an application may be made by a competitor, provided the owner can satisfy the MSA Karting Management Group that the chassis or engine was in South Africa prior to the expiry date of the previous homologation period.

In these circumstances the authorisation of homologation is restricted to that numbered chassis/engine of the named owner.

In such instances a fee will not be levied. Chassis or engines homologated by privateers for preceding homologation periods in terms of previous regulations may be extended as well in terms of these regulations.

- f) **TYRES** - The homologation of competition tyres per class are the preserve of the MSA Karting Management Group.

The application procedure and dates will be the same as applied for engines.

50 GENERAL

The MSA Karting Management Group reserves the right at any time to homologate kart racing equipment and wearing apparel outside of what is specified in these regulations. In such instances, MSA Karting Management Group will, at the time, determine the homologation fee, inspection costs and the period of homologation.

MSA Karting Management Group reserves the right, without obligation to any accredited dealer or individual MSA licence holder, to determine, modify or extend any homologation period at any time by notification in writing to that effect, as from the date stated in the said notification.

Furthermore, the MSA Karting Management Group is not bound to assign any reason whatsoever for any decisions in connection with homologation of racing kart equipment and wearing apparel.

51 HOMOLOGATED CHASSIS BRANDS

Refer to Appendix 1 for all approved chassis on www.motorsport.co.za

Chassis which do not appear on the above list will NOT be permitted to participate in any club, regional or national event, unless privately homologated in terms of Sec N 55 e) above.

52 HOMOLOGATED ENGINES

Engines which do not appear on the below list will NOT be permitted to participate in any club, regional or national event until homologated.

- a) **ROTAX CLASSES Regional - current MSA Karting ~~Exco~~ Specification Sheet published on www.motorsport.co.za**

- Bambino Class - Comer Model C50 and C52 engines complying with the current Specification Sheets.
- Rotax 125 MICRO MAX and MINI MAX - 125 ROTAX complying with the Rotax Max Challenge Technical Regulations as well as supplementary technical regulations for the current year.
- 125 JUNIOR MAX - 125 Junior MAX complying with the Rotax Technical Specifications.
- ROTAX Senior MAX Class - ROTAX 125 MAX complying with the Rotax Max Challenge Technical Regulations
- MASTER MAX CLASS - ROTAX MAX complying with the Rotax Max Challenge Technical for Senior Max
- ROTAX DD2 - ROTAX 125 DD2 complying with the Rotax Max Challenge Technical Regulations
- Rotax DD2 Masters Class - ROTAX 125 MAX DD2 complying with the Rotax Max Challenge Technical Regulations

- b) **ROK CLASSES - technical information which can be found on the MSA Website www.motorsport.co.za**
- KID ROK & MINI ROK Class - As per the technical information
 - OKJ - Vortex direct drive DDJ engine. Technical Specification on request from MSA as submitted part of homologation.
 - KZ2, KZ , KZ Masters Classes - Refer to current Regulations and Specifications for the National KZ2 and Interprovincial KZ Shifter classes.

SECTION N

53 PROCEDURES TO INTRODUCE A NEW CLASS

An accredited importer wishing to have a new class considered must: -

- a) Obtain a letter from clubs in each Region confirming that said clubs are willing to have the proposed new class demonstrated.
- b) The importer will own 5 units; which units may only be demonstrated and may not be sold.
- c) Once demonstrations at Clubs in each Region with at least 5 karts is successful and after receipt of competitor feedback and snags list (if any) and a survey of competitors to be shared with the Clubs in each Region where the demonstrations took place has been completed, with not less than Four clubs in Three regions supporting same, then: -
- d) The importer may apply for homologation of the class for use at club level only; once this has been approved the importer may proceed to sell engines.
- e) Competitors buying into this class/s must sign a disclaimer that MSA is not under any obligation to elevate said class/s beyond club status, nor responsible for the success or lack thereof even at club level.
- f) Based on interest and volume a regional committee may consider regional status after one (1) completed and successful year at club level.
- g) The applicable homologation renewal cycle will apply thereafter.

54 ACCREDITED IMPORTERS

- a) An annual renewal fee of R4950.00 (excl. VAT) is payable on application for renewal of the chassis homologation per brand. An annual renewal fee of R1000.00 (excl. VAT) is payable on application for renewal of the tyre and engine homologation
- b) Ensure all accredited importers and local manufacturers are on the MSA mailing list.
- c) Extend invitations to any consultative meeting held by MSA Karting Management Group as may be deemed necessary.

SA ACCREDITED KARTING IMPORTERS LIST

COMPANY	CONTACT DETAILS	HOMOLOGATED EQUIPMENT
BENONI SPORT & BUSINESS PARK (PTY) LTD	<p>Fabienne Lanz Cell : 079 525 8772 Email: fabiennerracing@hotmail.com</p> <p>Philip Swanepoel Cell : 082 777 8368 Email: info@formula-k.co.za</p>	Importers and Distributors of Formula K products, Accessories and Spares. Importer and Distributor of TM engines
ED MURRAY RACING CC	<p>Jennifer Verhuel Cell: 082 294 7485 Tel: 012 384 2303 Email: info@kart.co.za Website: www.kart.co.za</p>	Importers and Distributors of Mojo tyres, CRG and Top Kart Chassis, 52cc Comer Engines. AIM Mychron timing systems and other quality karting accessories.
FOR THE WIN MOTORSPORT	<p>Gary Lennon Cell: 072 853 8520 Email: garylennon1@yahoo.com Website: www.ftwmotorsport.com</p>	Importers and distributors of Tony Kart, Kosmic, Lando Norris and Exprit Chassis. Vortex Rok engines and spares. MIR, FeeM, Unipro, Greyhound seats and CZ Chains
FULLGAS	<p>Leon Hill Cell: 082 603 0663 Email: sales@fullgas.co.za Leon@rskart.co.za</p>	Importer and Distributor of RS and Praga Chassis and Spare Parts
I-CUBED DISTRIBUTION (PTY) LTD	<p>Brandon Whitley Cell: 081 497 9788 Email: info@icubedcapital.co.za</p> <p>Imraan Kajee Cell: 072 414 5252 Tel: 011 888 0027 Email: imraan@icubedcapital.co.za</p>	Importer and Distributor of Parolin Chassis and Spare parts
KORRIDAS	<p>Paulo Dos Santos Cell: 083 406 9356 Email: paulo.dos.santos@oracle.com</p>	Importer and Distributor of Haase Chassis and spare parts
	<p>Ralph Odendaal Cell: 076 817 5287</p>	Importers and Distributors of Intrepid Chassis. Engine Hire

RALPH ODENDAAL RACING - T/A PUNJABI KART PARTS	Email: intrepidkartsa@gmail.com	and service centre. Track side assistance and driver training and suppliers of race apparel
RICCIARDO KART SA	Neil Smith Cell: 082 886 2444 Tel: 011 849 8495 Email: sales@ricciardokart.co.za Website: www.ricciardokart.co.za	Importers and Distributor of BirelArt Karts, Ricciardo karts and Freeline spares. Service centre, kart preparation, race kart rentals and arrive and drive packages
SQUADRA CORSE	Mpho Elijah Gumbi Cell: 083 536 8694 Email: mpho.g@squadracorse.co.za Unit C1, Zwartkops Raceway	Importer and Distributor of Fernando Alonso and Kart Republic Chassis
EPIC KARTING	Tom Martens Cell: 072 085 4274 Email: race@sodikart.co.za info@checkpointmotorsport.co.za Old Balgowan Farm, R103, Howick 3275 Website: www.sodikart.co.za Website: www.checkpointmotorsport.co.za	Importer and Distributor of Sodi Chassis